

Wall Mounted Rotary Panel



Model No.: T1-K, T2-K, T3-K

1-3 color/Glass panel/Rotary dimming/DC input/3 channel constant voltage PWM output/Wireless remote control



T1-K



T2-K



T3-K

CE RoHS LVD

Features

- Rotary panel single color, dual color or RGB PWM constant voltage controller.
- Rotate knob to change RGB color, color temperature or brightness.
- Compatibility with Skydance's 2.4G dimming remote control.
- Push/Rotate with chord tones and LED indicator.

Technical Parameters

Input and Output			
Model	T1-K	T2-K	T3-K
Input voltage	12-24VDC	12-24VDC	12-24VDC
Input current	12.5A	10.5A	12.5A
Output voltage	3 x (12-24)VDC	2 x (12-24)VDC	3 x (12-24)VDC
Output current	3CH,4A/CH	2CH,5A/CH	3CH,4A/CH
Output power	144-288W	120-240W	144-288W
Output type	Constant voltage	Constant voltage	Constant voltage
Light type	Single color	Dual color	RGB

Safety and EMC	
EMC standard (EMC)	EN301 489,EN 62479
Safety standard(LVD)	EN60950
Radio Equipment(RED)	EN300 328
Certification	CE,EMC,LVD,RED

Environment	
Operation temperature	Ta: -30 °C ~ +55 °C
Case temperature (Max.)	Tc: +85 °C
IP rating	IP20

Warranty and Protection	
Warranty	5 years
Protection	Reverse Polarity

Knob function

T1-K Single color dimmer

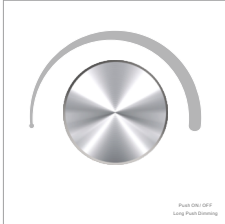

- **Push:** Turn on or off light.

After turn on light:

- **Rotate:** Rotate knob to adjust brightness (2.5 turns, 50 levels).
- **Long push(1-6s):** Continuous 256 levels brightness adjustment.

T2-K Dual color temperature

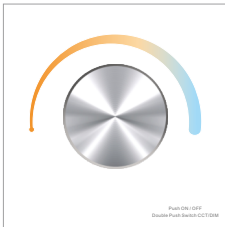

- **Push:** Turn on or off light.

After turn on light:

- **Rotate:** Rotate knob to change color temperature or brightness (2.5 turns, 50 levels).
- **Push twice:** Switch between color temperature or brightness adjustment.
- **Long push(1-6s):** Continuous 256 levels brightness adjustment.

T3-K RGB

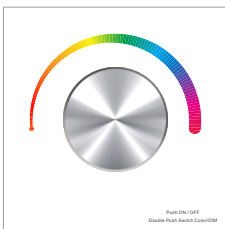

- **Push:** Turn on or off light.

After turn on light:

- **Rotate:** Rotate knob to change RGB color (3 turns, 60 colors) or brightness (2.5 turns, 50 levels).
- **Push twice:** Switch between RGB color or brightness adjustment.
- **Long push(1-6s):** Continuous 256 levels brightness adjustment.

Note: After push knob to turn off light, long press push knob for 5 seconds will turn on or turn off tone.

Wiring diagram

• T1-K

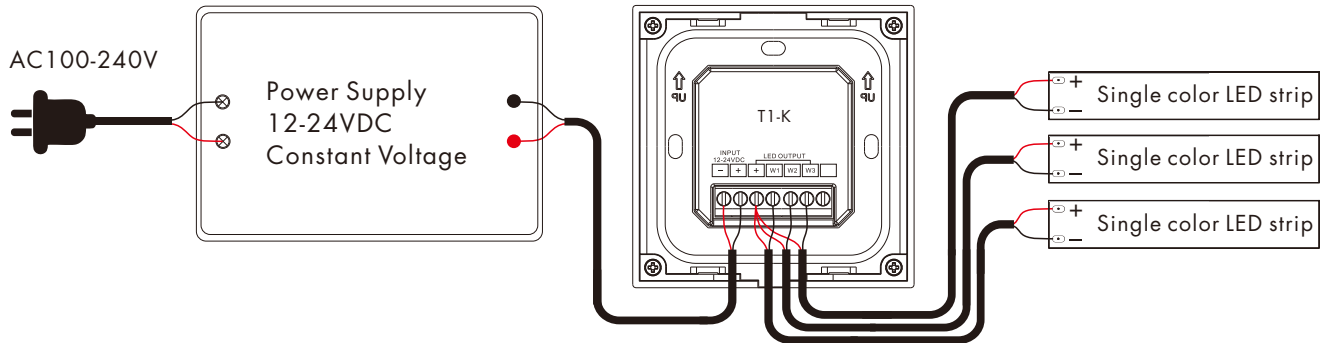

• T2-K

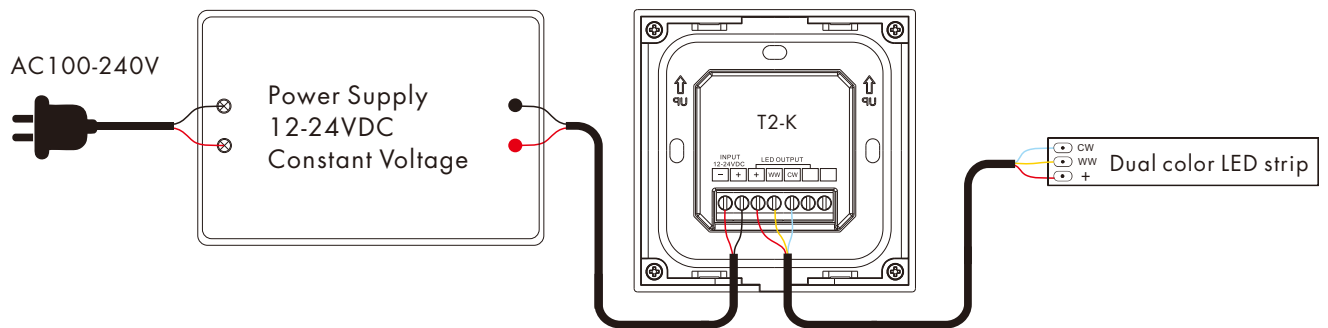

• T3-K

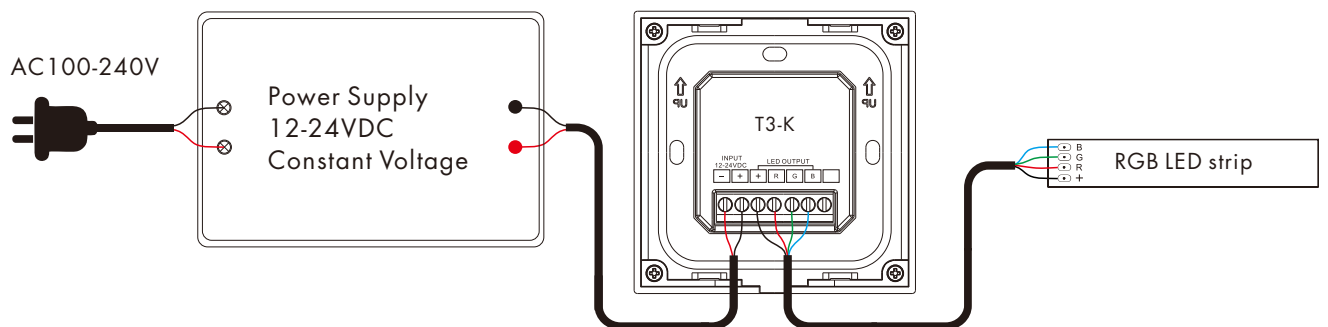

LED power supply voltage and power select :

- 12V lamp, Input 12V power supply, can load 0~144W,
- 24V lamp, Input 24V power supply, can load 0~288W, The power supply power must larger than load power 20%.

Match Remote Control (two match ways)

The rotary panel controller can also match with the RF remote (optional).
End user can choose the suitable match/delete ways. Two options are offered for selection:

Use Knob

Match:

Turn on light, turn off, immediately push the knob for 5s, then press on/off key (single zone remote) or zone key (multiple zone remote) of the RF remote within 5s.

Delete:

Turn on light, turn off, immediately push the knob for 10s, delete all matched RF remote.

Use Power Restart

Match:

Switch off the power, then switch on power again, immediately short press on/off key (single zone remote) or zone key (multiple zone remote) 3 times on the remote. The light blinks 3 times means match is successful.

Delete:

Switch off the power, then switch on power again, immediately short press on/off key (single zone remote) or zone key (multiple zone remote) 5 times on the remote. The light blinks 5 times means all matched remotes were deleted.

Mechanical Structures and Installations

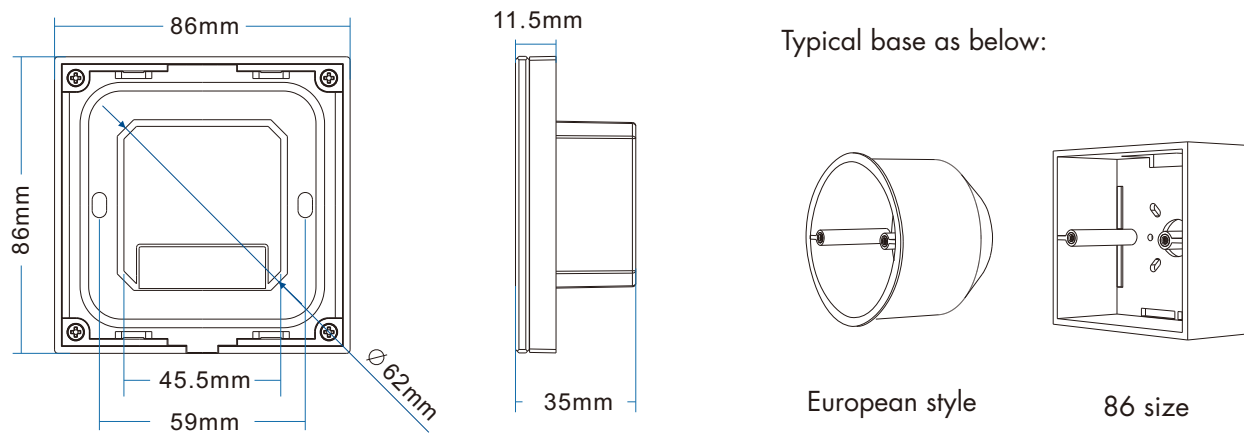

Installation diagram:

